

SECTION A-A

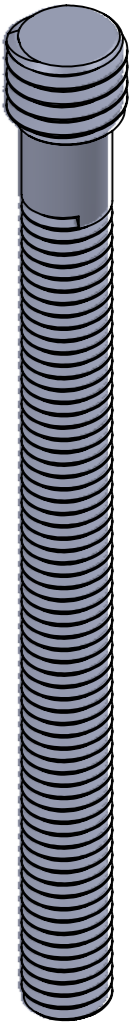
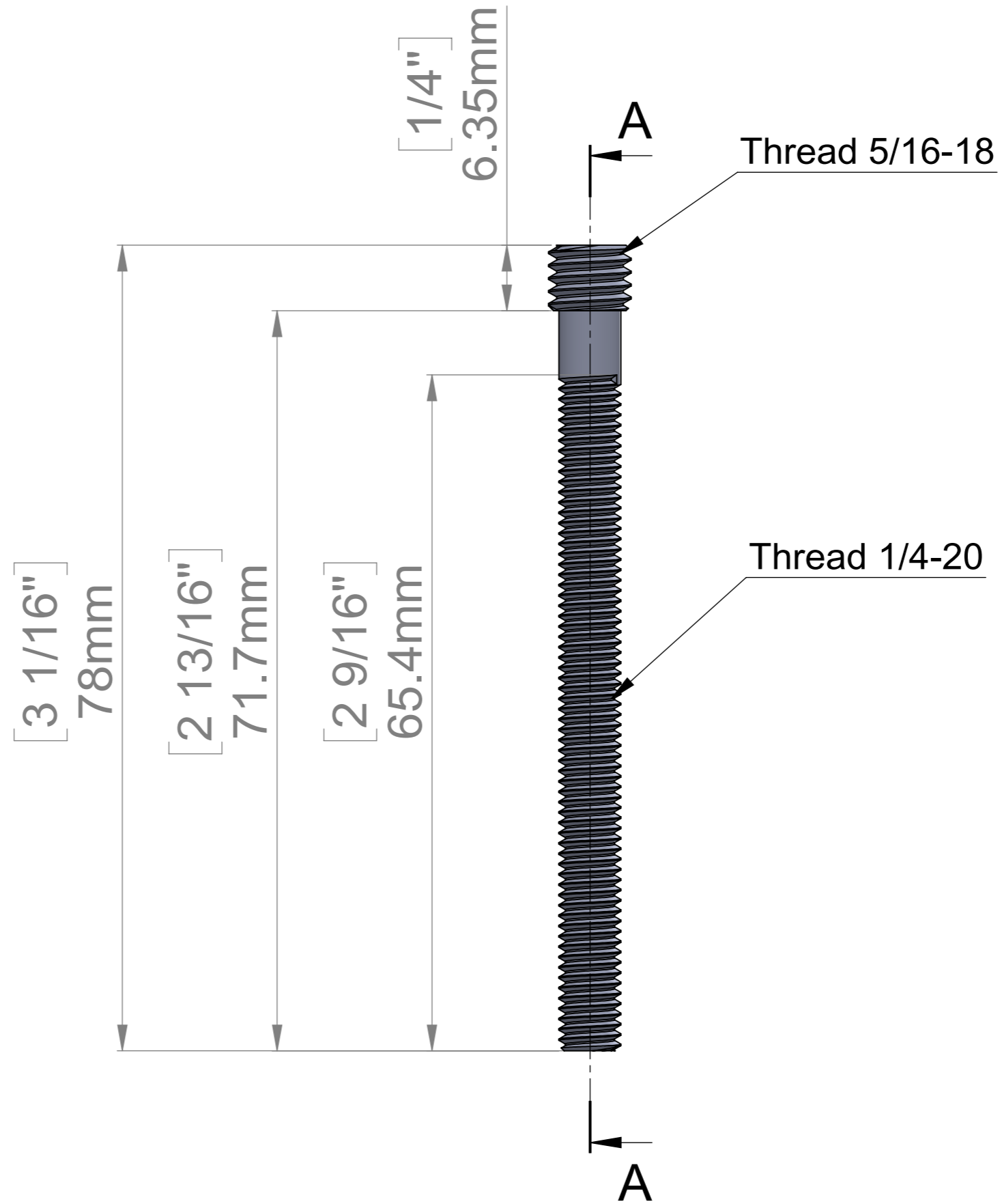
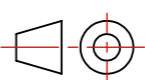

Title : CSC5			Scale : 2:1		
			Sizes : Letter Landscape	Customer:	
		Material: Steel	Finish: Zinc	Qty :	Rep :
		N°programme laser	N°prog. Mécanum.	N° Plan : FAH25-12	